

DFR



Rodete de álabes curvados hacia atrás
Backward curved impeller

Ventilador centrífugo con accionamiento por poleas y correas o junta. Fabricados en chapa de acero protegida contra la corrosión mediante tratamiento por cataforesis + pintura poliuretana. Temperaturas del aire a transportar -20°C/+40°C (60°C con cojinetes C3) en continuo.

Sistemas de montaje

- SISTEMA 6: rodete montado en el eje con rodamientos en ambos lados de la carcasa, sostenidos por la misma carcasa.
- SISTEMA 17: Acoplamiento mediante junta. Ejecución normalmente igual al sistema 6, pero con base para el motor.
- SISTEMA 18: Generalmente como el sistema 6 pero incluyendo bancada común para el motor y el ventilador.
- SISTEMA 19: Generalmente como el sistema 6 pero con el motor soportado por la voluta.

Motores

De 2, 4 ó 6 polos, de alta eficiencia IE 3* (las r.p.m. de cada motor se adaptarán al cálculo de cada transmisión), tensión de alimentación trifásica 230/400V 50Hz hasta tamaño motor 132 y 400/690V

Double inlet centrifugal fans, belt drive or coupling drive. Manufactured from steel sheet protected with cataforesis primer + polyurethane paint finish. Designed to continuously circulate air from -20°C up to 40°C (60°C with C3 bearings).

Assembly systems

- ARRANGEMENT 6: Impeller mounted on shaft running in bearings on each side of casing and supported by the fan casing.
- ARRANGEMENT 17: For coupling drive. Generally as arrangement 6 but with a base for the driving motor.
- ARRANGEMENT 18: Generally as arrangement 6 but with a fan and motor supported by common base frame.
- ARRANGEMENT 19: Generally as arrangement 6 but with the motor supported by the fan scroll.

Motors

2, 4 or 6 pole, IE 3 high efficiency (the rpm of each motor will be adapted according to the calculation for each*

50Hz para motores de mayor dimensión. Protección IP55, Clase F.

* A partir de 0,75 kW el motor puede ser de eficiencia IE 2 controlado por convertidor de frecuencia.

Bajo pedido

- Fabricación en diferentes materiales constructivos.
- Motores de 2 velocidades.
- Versiones de 60 Hz.
- Pintura en diferentes RAL.
- Trampilla de inspección, purga de drenaje, distintos tipos de estanqueidad a nivel de voluta y de paso de eje.
- Calorifugado.

Versiones ATEX

Bajo pedido, versiones antiexplosivas según la Directiva ATEX para modelos trifásicos:

Para trabajar a temperaturas de -20°C a +60°C, presión ambiente (absoluta) de 0,8 bar hasta 1,1 bar, según EN 14986.

• Gas:

- ⊗ 3G IIB T2-T3, Motor ExnA (sólo para categoría 3G)
- ⊗ 3G IIB+H2 T2-T3, Motor ExnA (sólo para categoría 3G)

drive), three-phase 230/400V 50Hz up to motor size 132 and 400/690V 50Hz for higher motors. IP55, Class F protection.

* From 0,75kW, motor can be IE 2 and controlled by VSD.

On request

- Manufactured from different materials.
- 2-speed motors.
- 60 Hz versions.
- Painted in different RAL colour.
- Inspection door, draining, different seals on scroll and shaft access.
- Thermal insulation lagging.

ATEX versions

On request, explosion proof versions in accordance with ATEX directive for three phase models:

Ambient temperature -20°C to +60°C, ambient pressure (abs.) 0,8 bar to 1,1 bar according to EN 14986.

• Gas:

- ⊗ 3G IIB T2-T3, Motor ExnA (only for 3G zone)
- ⊗ 3G IIB+H2 T2-T3, Motor ExnA (only for 3G zone)

CUADRO DE APLICACIONES TABLE OF APPLICATIONS	
Aire a transportar Air Type	Cantidad de polvo Dust quantity (mg/m ³)
Aire limpio Clean air	<50

RODETE ÁLABES CURVADOS HACIA ATRÁS DE DOBLE ASPIRACIÓN DOUBLE INLET BACKWARD CURVED IMPELLER



CARACTERÍSTICAS TÉCNICAS / TECHNICAL FEATURES

Es imprescindible comprobar que las características eléctricas (voltaje, intensidad, frecuencia, etc.) del motor que aparecen en la placa del mismo son compatibles con las de la instalación.

Please, check that electrical features (voltage, current, frequency, etc.) are suitable with your installation.

Modelo Model	Caudal máximo Maximum airflow (m ³ /h)	Potencia motor máxima Maximum motor power (kW)	Peso Weight (kg) ⁽¹⁾	Momento de inercia Moment of inertia (kg·m ²) ⁽²⁾
DFR 401 N6A	23.090	18,5	100	0,43
DFR 451 N6A	29.230	22,0	132	0,80
DFR 501 N6A	39.370	30,0	160	1,30
DFR 561 N6A	49.260	37,0	212	2,12
DFR 631 N6A	63.360	45,0	265	3,50
DFR 711 N6A	81.830	55,0	375	6,50
DFR 801 N6A	106.230	75,0	450	10,80
DFR 901 N6A	131.670	90,0	630	17,80
DFR 1001 N6A	150.720	110,0	800	31,80
DFR 1121 N6A	181.890	160,0	1.180	55,30
DFR 1251 N6A	220.235	160,0	1.600	97,00
DFR 1401 N6A	265.680	200,0	2.120	176,00
DFR 1601 N6A	343.730	315,0	2.800	298,00
DFR 1801 N6A	443.520	400,0	3.550	517,00
DFR 2001 N6A	535.680	400,0	4.750	999,00

¹ Para ejecución 6 y orientación LG270 ó RD270 / For arrangement 6 and LG270 or RD270 position

² Momento de inercia del rodetes / Impeller's moment of inertia

SOPORTES SISTEMA 6 / SUPPORTS FOR ARRANGEMENT 6

Modelo / Clase Model / Class	401-1 / 2-3	451-1 / 2-3	501-1 / 2-3	561-1 / 2-3	631-1 / 2-3	711-1 / 2-3	801-1 / 2-3	901-1 / 2-3
Soporte tipo Support type	SN 509 C42 28 / 38	SN 510 C48 32 / 42	SN 511 C55 38 / 48	SN 512 C60 38 / 48	SN 513 C65 42 / 55	SN 516 C75 48 / 60	SN 517 C80 55 / 65	SN 518 C90 60 / 75
Modelo / Clase Model / Class	1001-1 / 2-3	1121-1 / 2-3	1251-1 / 2-3	1401-1 / 2-3	1601-1 / 2-3	1801-1 / 2-3	2001-1 / 2-3	
Soporte tipo Support type	SN 518 CL90 65 / 75	SN 520 C100 75 / 80	SN 522 C110 80 / 90	SN 524 C120 90 / 100	SN 526 C130 100 / 100	SN 528 C140 110 / 120	SN 530 C150 120 / 130	

Ver información adicional / See additional information

MOTORES SISTEMA 19 / MOTOR SIZE FOR ARRANGEMENT 19

Modelo Model	401	451-501	561	631-711	801-901	1001	1121	1251	1401
Tamaño motor Motor size	≤ 112 M2	≤ 132 S2	≤ 132 M2	≤ 160 L4	≤ 180 L4	≤ 200 L4	≤ 225 S4	≤ 225 M6	≤ 250 M6

RODETE ÁLABES CURVADOS HACIA ATRÁS DE DOBLE ASPIRACIÓN DOUBLE INLET BACKWARD CURVED IMPELLER



CURVAS CARACTERÍSTICAS (a la descarga) / PERFORMANCE CURVES (at outlet)

- Ptot: Presión total en Pa.
- Ptot: Total pressure in Pa.

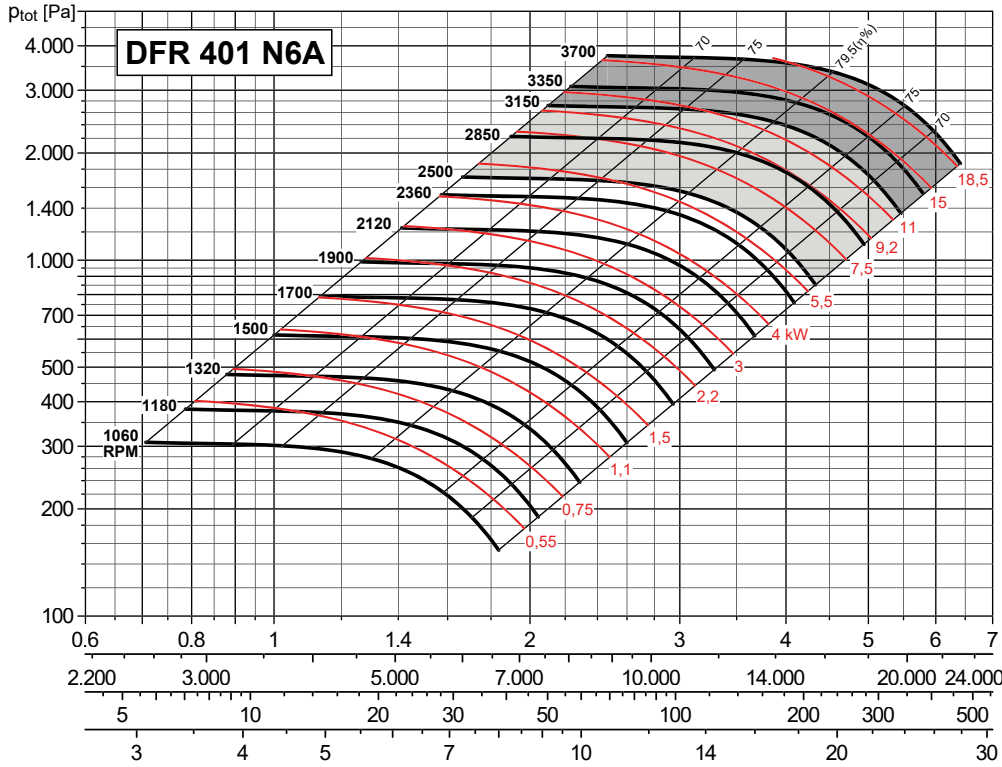

MAX. RPM

- ≤ 40°C
- 41 ÷ 60°C

Clase 1	Clase 2	Clase 3
2500	3150	3700
2320	3000	3470

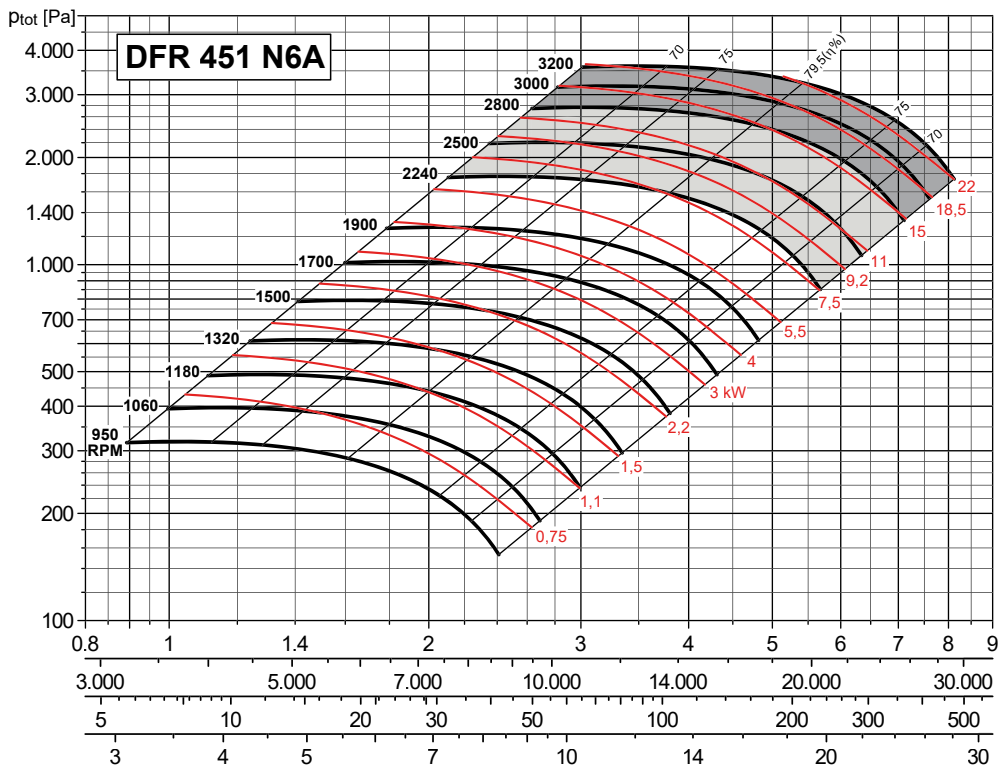

MAX. RPM

- ≤ 40°C
- 41 ÷ 60°C

Clase 1	Clase 2	Clase 3
2240	2800	3200
2120	2650	3020

RODETE ÁLABES CURVADOS HACIA ATRÁS DE DOBLE ASPIRACIÓN DOUBLE INLET BACKWARD CURVED IMPELLER



CURVAS CARACTERÍSTICAS (a la descarga) / PERFORMANCE CURVES (at outlet)

- Ptot: Presión total en Pa.
- Ptot: Total pressure in Pa.

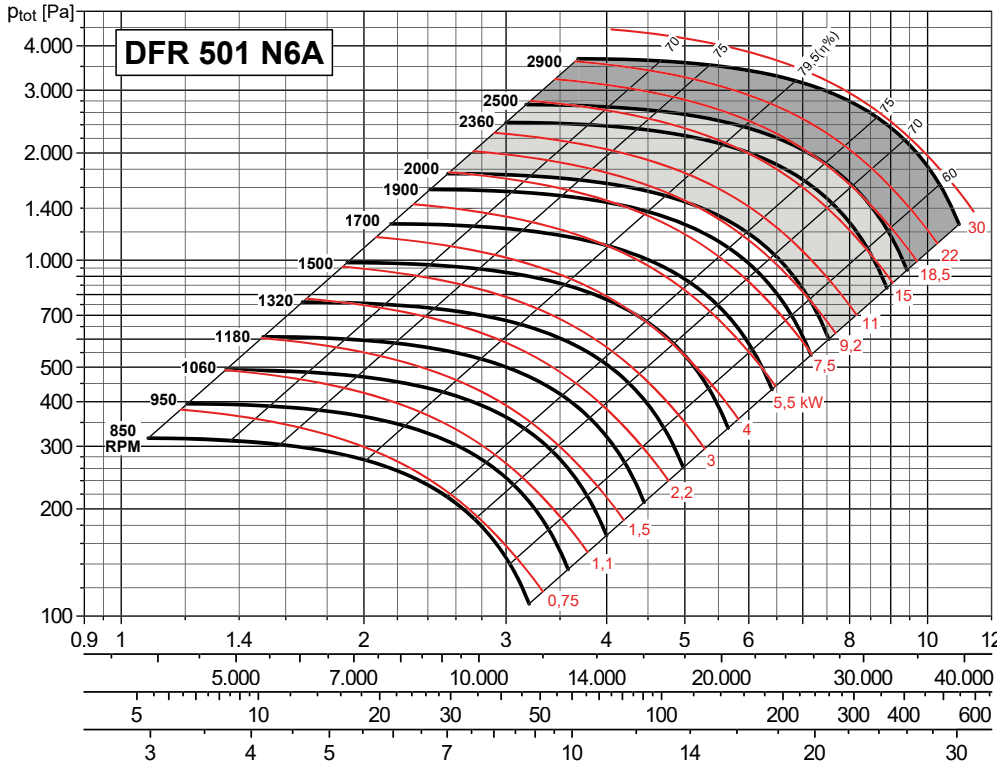

MAX. RPM

- ≤ 40°C
- 41 ÷ 60°C

Clase 1	Clase 2	Clase 3
2000	2500	2900
1900	2320	2760

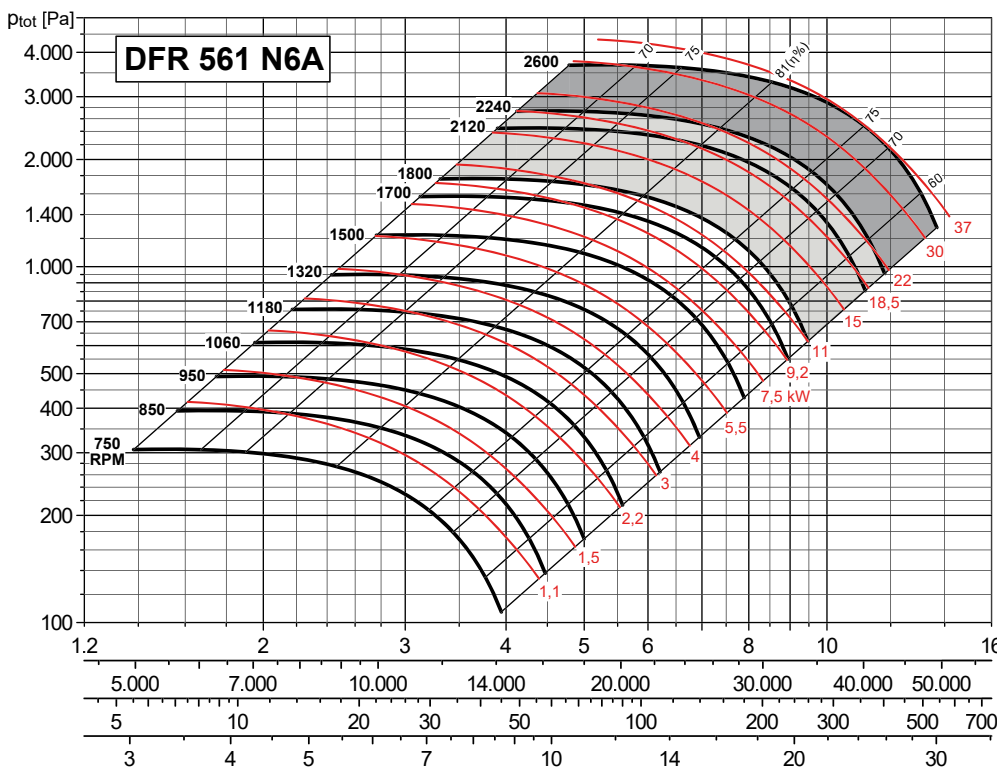

MAX. RPM

- ≤ 40°C
- 41 ÷ 60°C

Clase 1	Clase 2	Clase 3
1800	2240	2600
1700	2120	2470

RODETE ÁLABES CURVADOS HACIA ATRÁS DE DOBLE ASPIRACIÓN DOUBLE INLET BACKWARD CURVED IMPELLER



CURVAS CARACTERÍSTICAS (a la descarga) / PERFORMANCE CURVES (at outlet)

- Ptot: Presión total en Pa.
- Ptot: Total pressure in Pa.

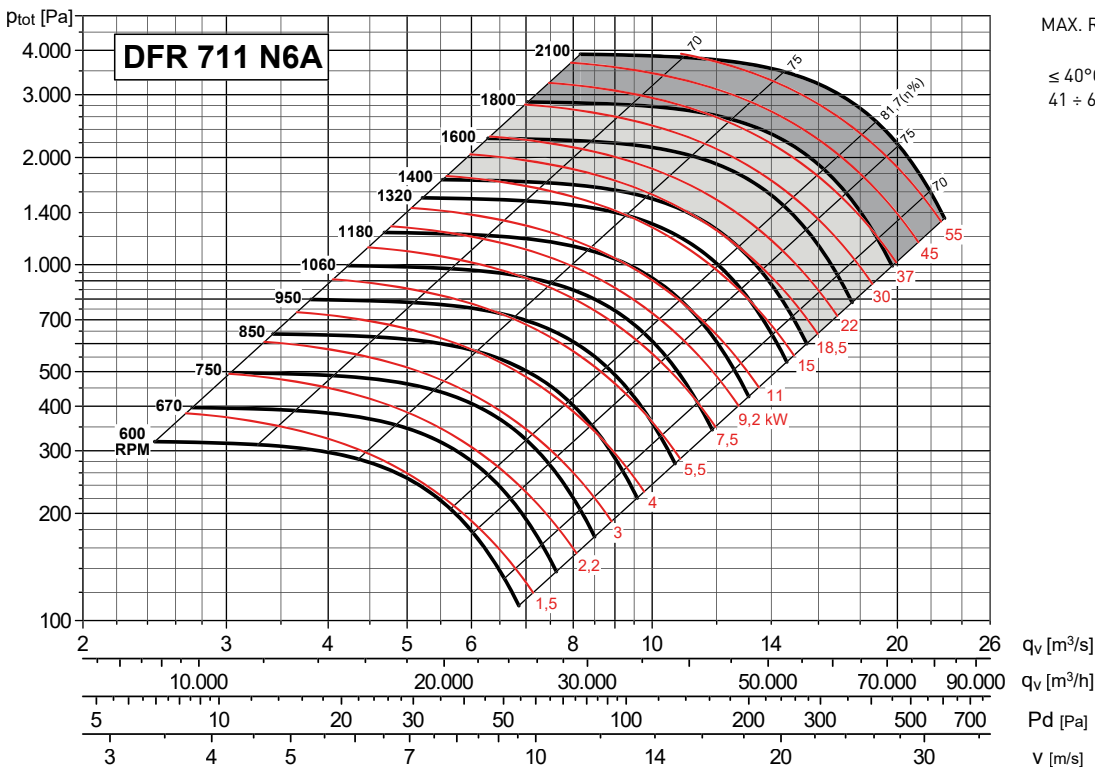
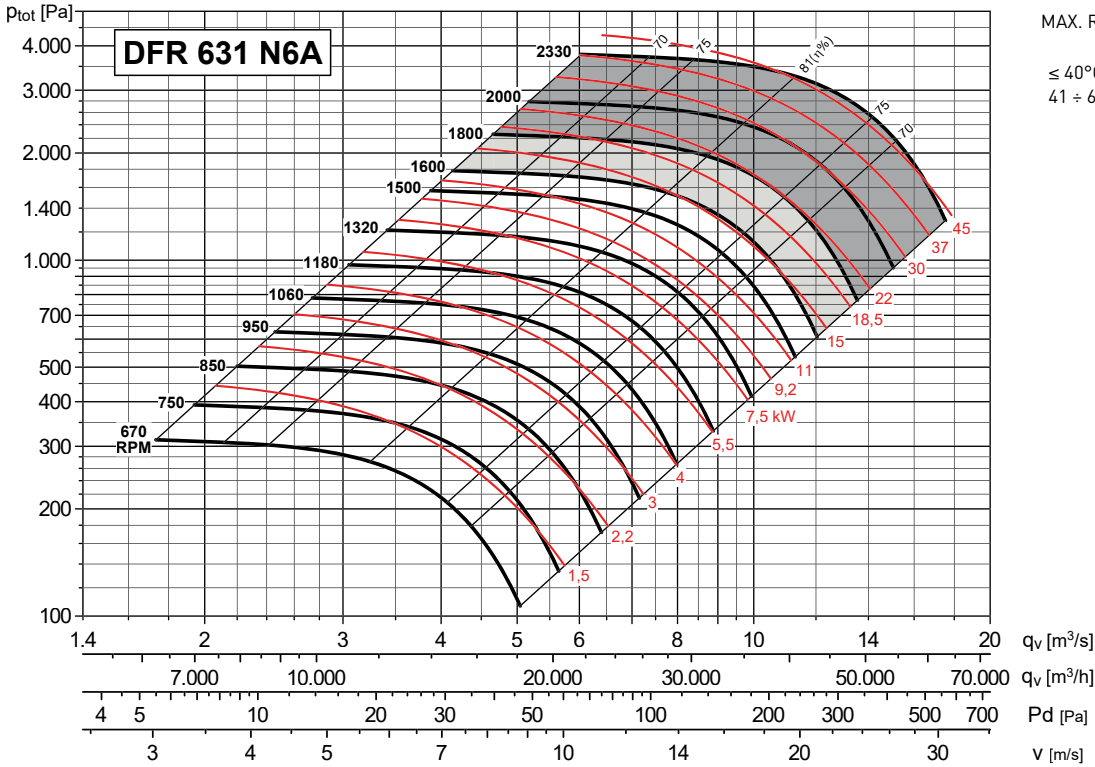

RODETE ÁLABES CURVADOS HACIA ATRÁS DE DOBLE ASPIRACIÓN DOUBLE INLET BACKWARD CURVED IMPELLER



CURVAS CARACTERÍSTICAS (a la descarga) / PERFORMANCE CURVES (at outlet)

- Ptot: Presión total en Pa.
- Ptot: Total pressure in Pa.

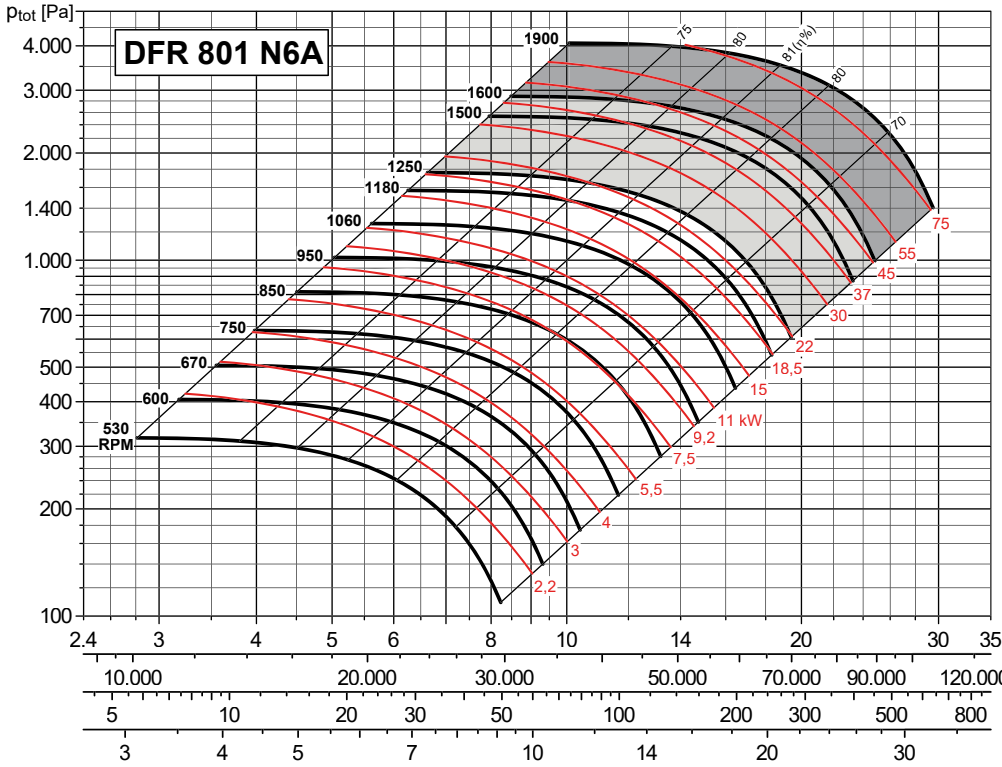

MAX. RPM

Class	Class 1	Class 2	Class 3
≤ 40°C	1250	1600	1900
41 ÷ 60°C	1180	1500	1800

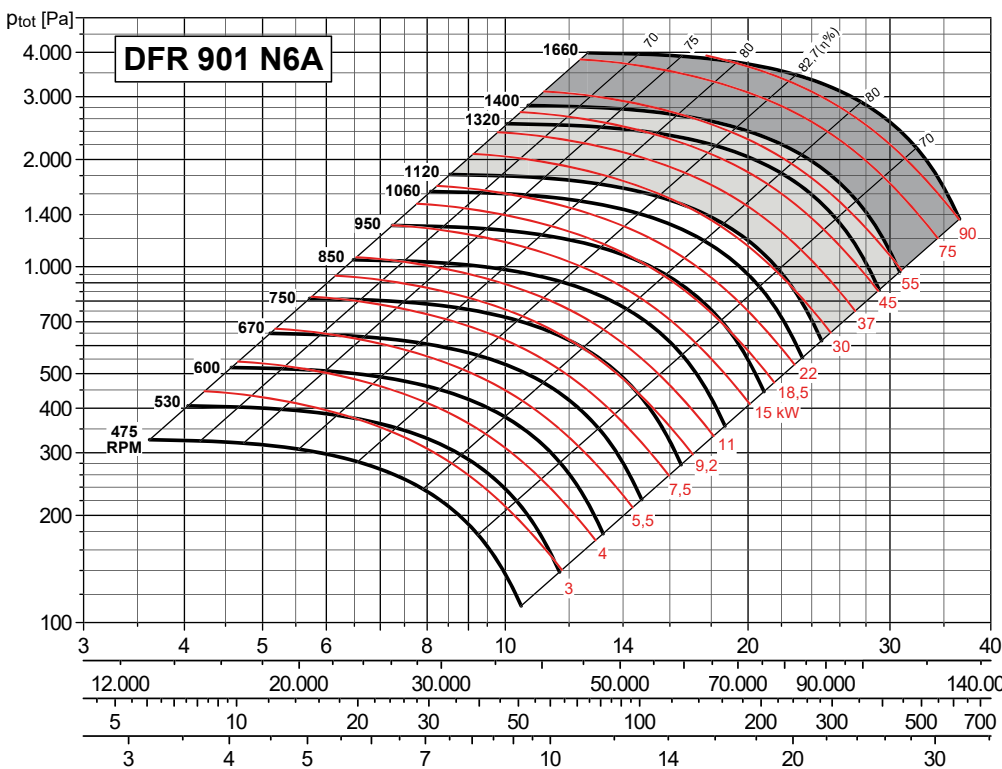

MAX. RPM

Class	Class 1	Class 2	Class 3
≤ 40°C	1120	1400	1660
41 ÷ 60°C	1060	1320	1570

RODETE ÁLABES CURVADOS HACIA ATRÁS DE DOBLE ASPIRACIÓN DOUBLE INLET BACKWARD CURVED IMPELLER



CURVAS CARACTERÍSTICAS (a la descarga) / PERFORMANCE CURVES (at outlet)

- Ptot: Presión total en Pa.
- Ptot: Total pressure in Pa.

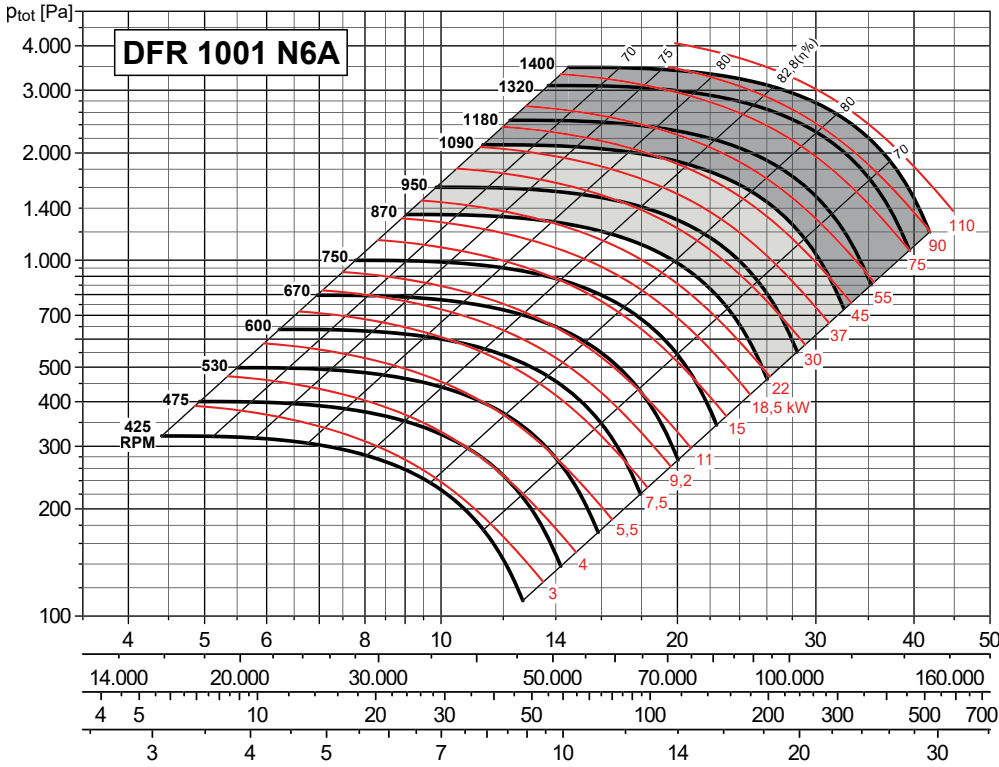

MAX. RPM

- ≤ 40°C
- 41 ÷ 60°C

Clase 1	Clase 2	Clase 3
870	1090	1400
820	1030	1300

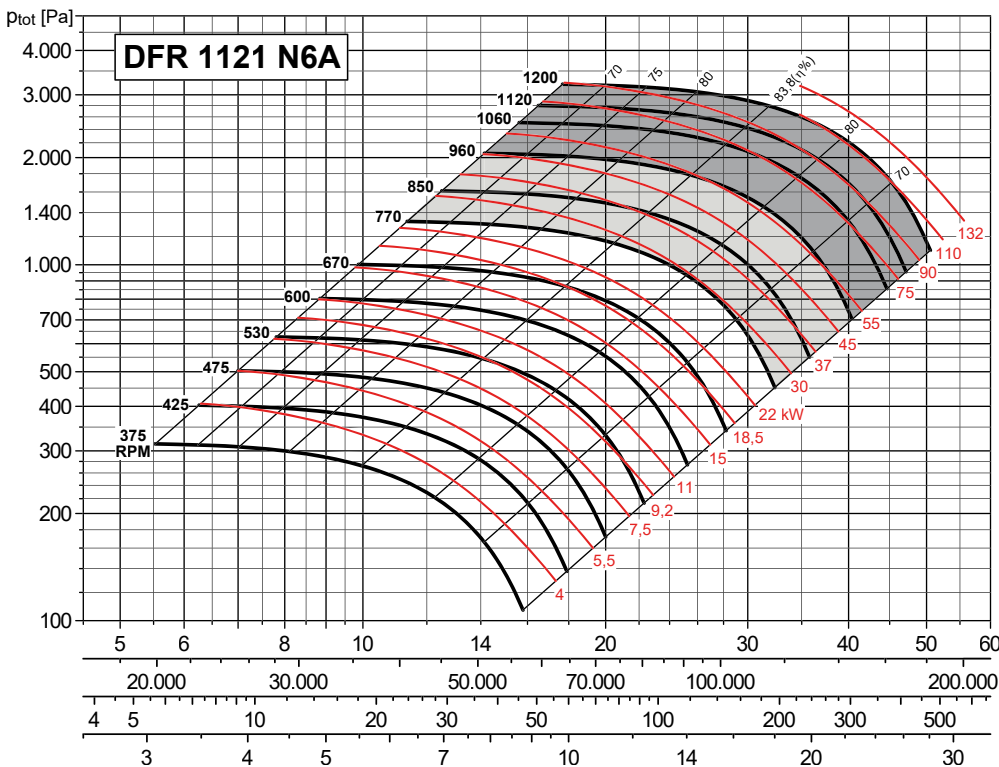

MAX. RPM

- ≤ 40°C
- 41 ÷ 60°C

Clase 1	Clase 2	Clase 3
770	960	1200
730	910	1130

RODETE ÁLABES CURVADOS HACIA ATRÁS DE DOBLE ASPIRACIÓN DOUBLE INLET BACKWARD CURVED IMPELLER



CURVAS CARACTERÍSTICAS (a la descarga) / PERFORMANCE CURVES (at outlet)

- Ptot: Presión total en Pa.
- Ptot: Total pressure in Pa.

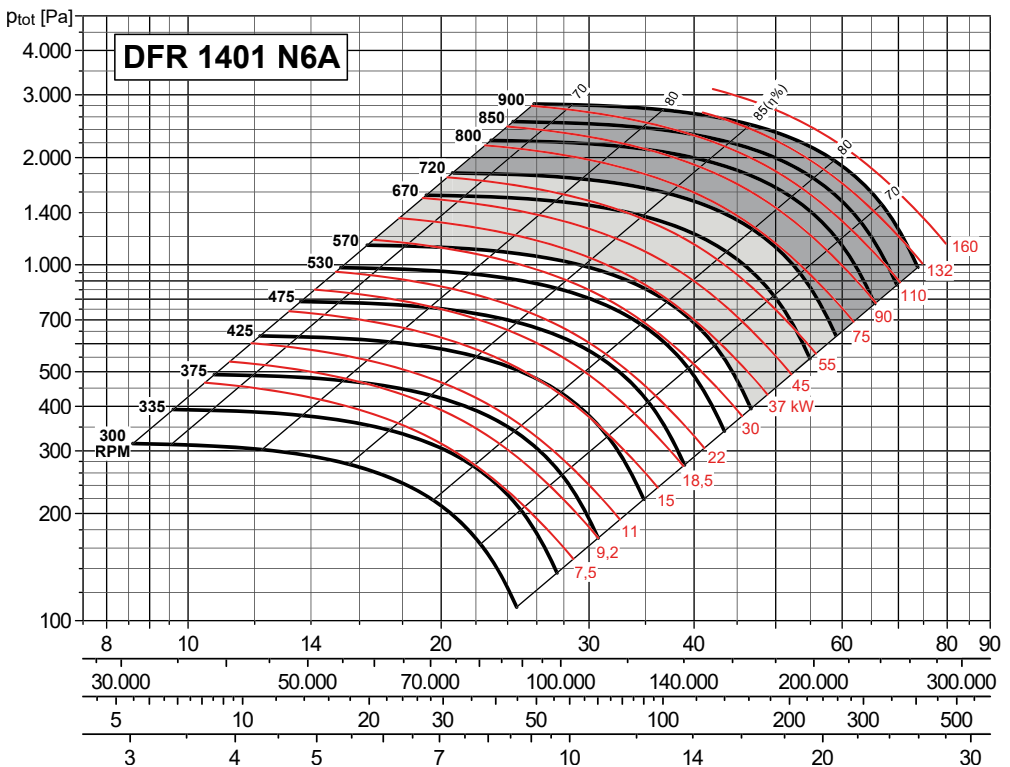
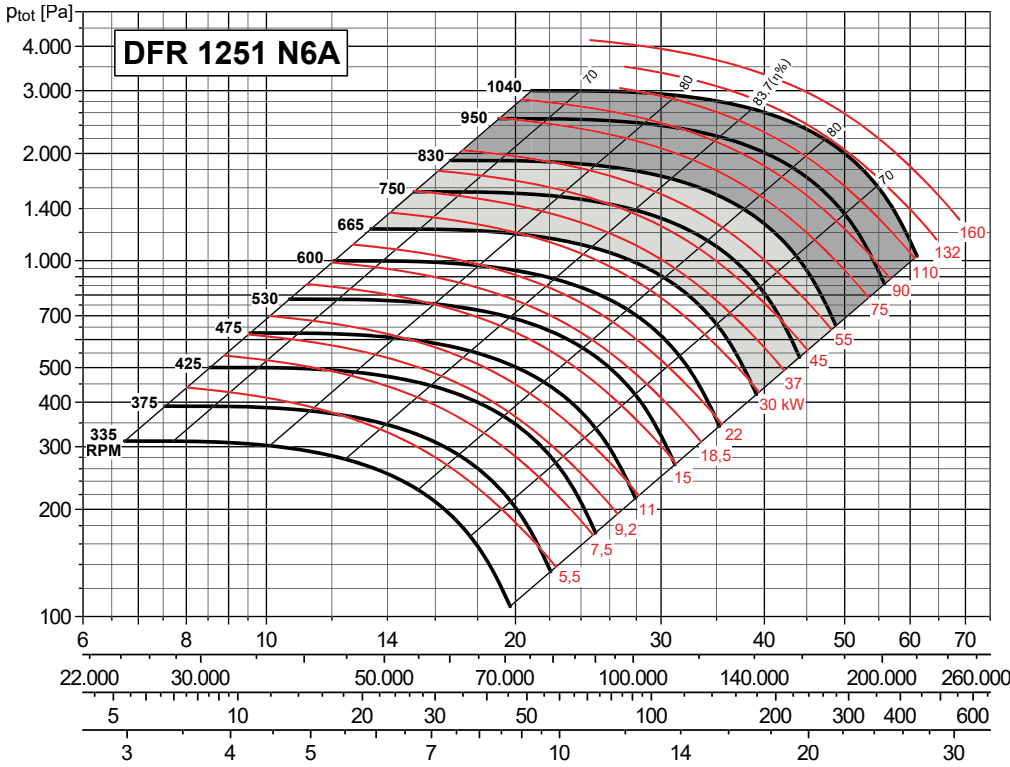

RODETE ÁLABES CURVADOS HACIA ATRÁS DE DOBLE ASPIRACIÓN DOUBLE INLET BACKWARD CURVED IMPELLER



CURVAS CARACTERÍSTICAS (a la descarga) / PERFORMANCE CURVES (at outlet)

- Ptot: Presión total en Pa.
- Ptot: Total pressure in Pa.

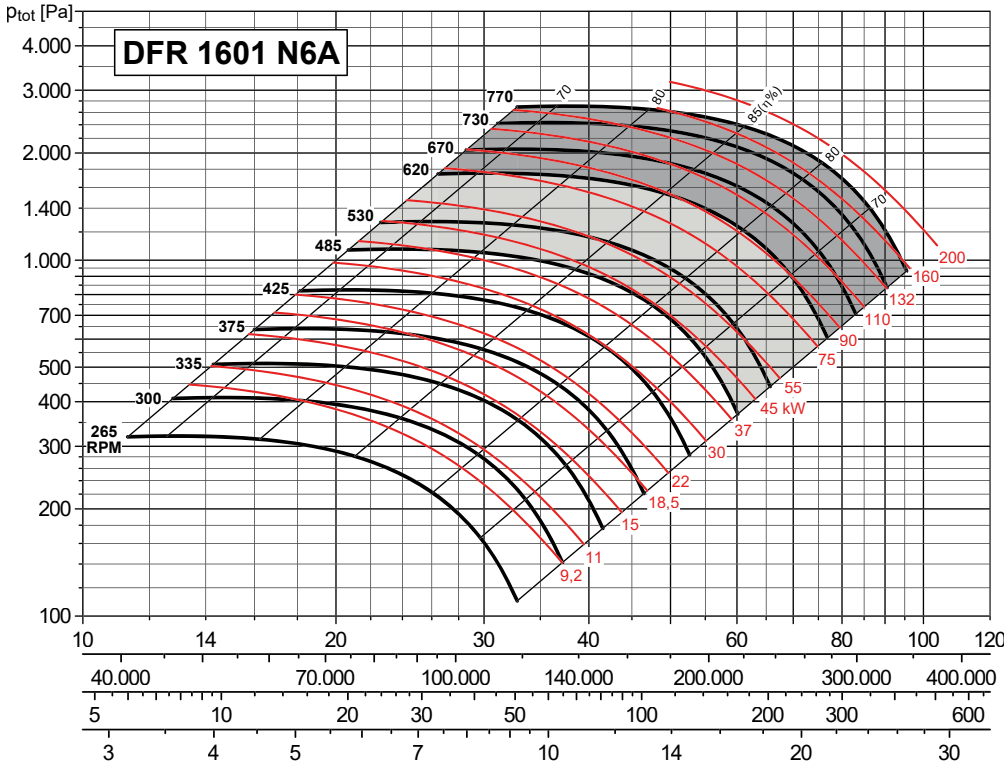

MAX. RPM
≤ 40°C
41 ÷ 60°C

Clase 1	Clase 2	Clase 3
485	620	770
460	580	730

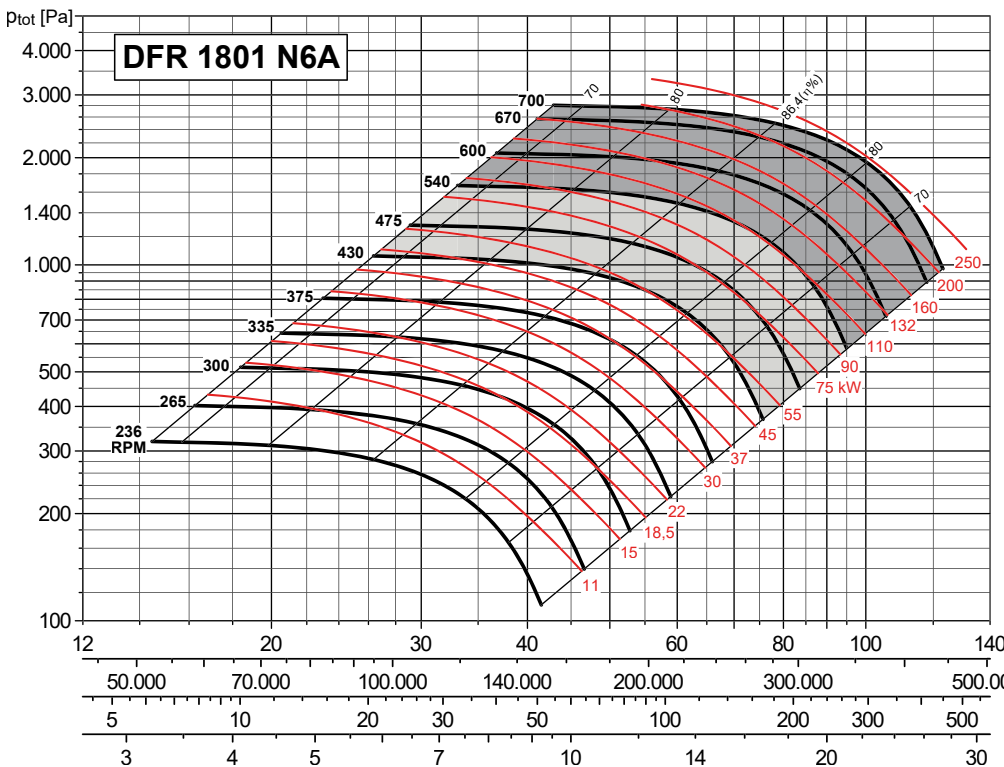

MAX. RPM
≤ 40°C
41 ÷ 60°C

Clase 1	Clase 2	Clase 3
430	540	700
410	515	655

CURVAS CARACTERÍSTICAS (a la descarga) / PERFORMANCE CURVES (at outlet)

- P_{tot}: Presión total en Pa.
- P_{tot}: Total pressure in Pa.

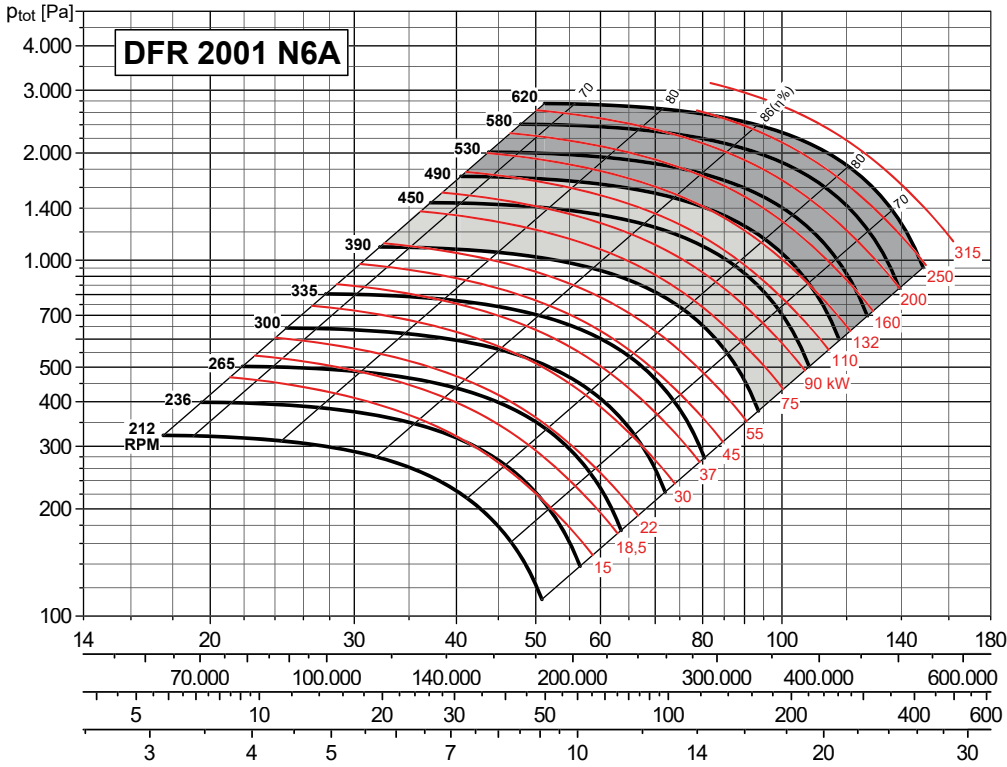

MAX. RPM

MAX. RPM	Class 1	Class 2	Class 3
≤ 40°C	390	490	620
41 ÷ 60°C	365	460	580

RODETE ÁLABES CURVADOS HACIA ATRÁS DE DOBLE ASPIRACIÓN DOUBLE INLET BACKWARD CURVED IMPELLER



DIMENSIONES (mm) (Ejecución 6) / DIMENSIONS (mm) (Arrangement 6)

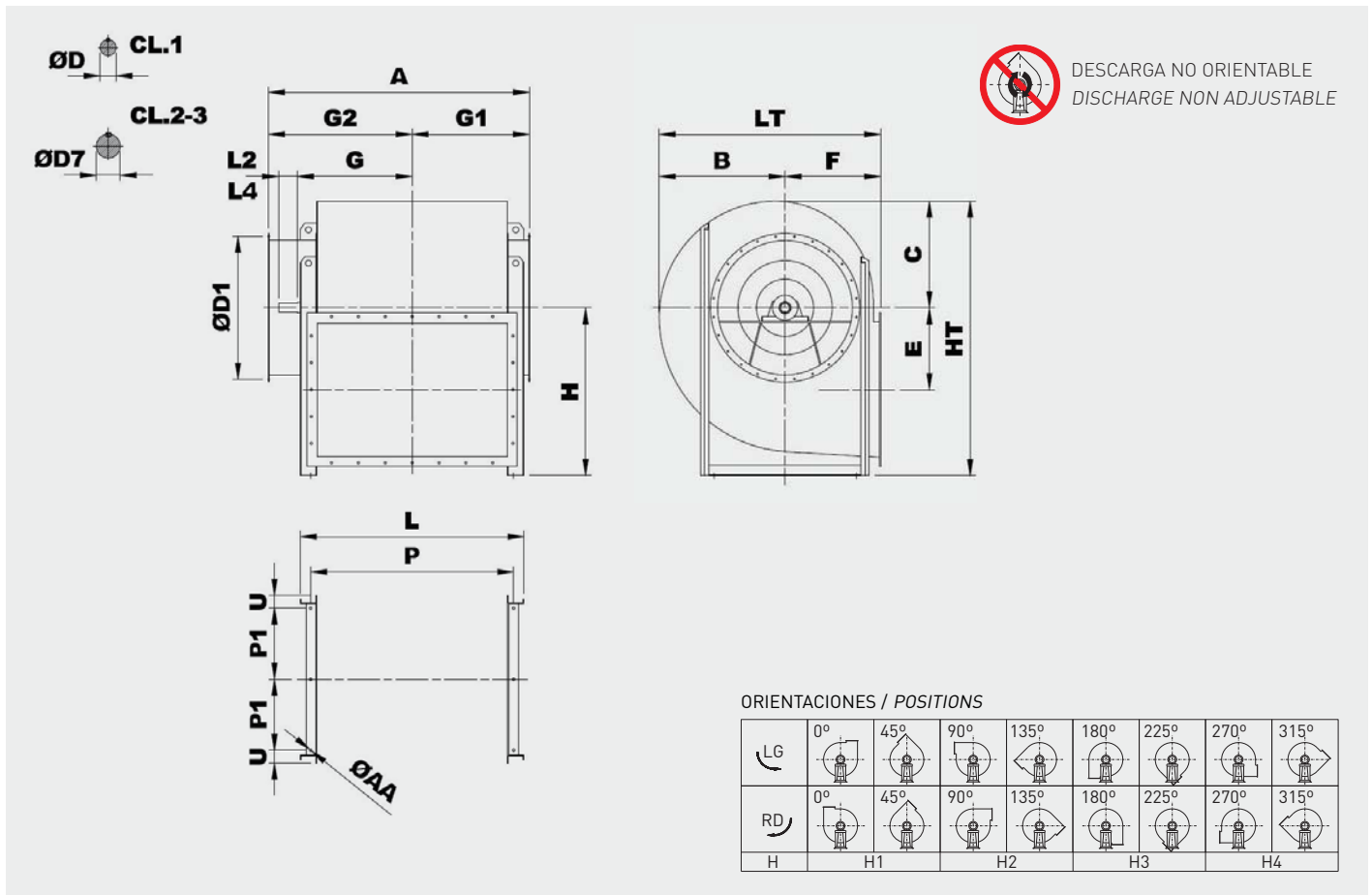

Tipo ventilador Fan type	Ventilador Fan											Eje Shaft				Base Base								
	A	B	C	Ø D1	E	F	G	G1	G2	H				HT	LT	Ø D	Ø D7	L2	L4	L	P	P1	U	Ø AA
										H1	H2	H3	H4											
DFR 401 N6A	895	375	330	448	243	285	367	380	515	500	500	285	500	830	660	28	38	60 CL1	80 CL2-3	695	635	217	70	14
DFR 451 N6A	990	425	370	497	273	320	406	415	575	560	560	320	560	930	745	32	42	80 CL1	110 CL2-3	764	704	242	70	14
DFR 501 N6A	1080	470	410	551	301	360	455	465	615	630	630	360	630	1040	830	38	48	80 CL 1	110 CL2-3	841	781	267	70	14
DFR 561 N6A	1190	525	455	629	331	400	508	505	685	530	475	400	710	1165	925	38	48	80 CL1	110 CL2-3	927	867	308	70	17
DFR 631 N6A	1300	590	515	698	375	450	557	565	735	600	530	450	800	1315	1040	42	55	110 CL1-2-3	-	1024	964	343	70	17
DFR 711 N6A	1490	665	565	775	431	500	626	665	825	670	600	500	850	1415	1165	48	60	110 CL1	140 CL2-3	1153	1083	386	80	19
DFR 801 N6A	1615	740	630	861	482	560	693	730	885	750	670	560	1000	1630	1300	55	65	110 CL1	140 CL2-3	1276	1206	431	80	19
DFR 901 N6A	1790	830	705	958	543	630	776	795	995	850	710	630	1120	1825	1460	60	75	140 CL1-2-3	-	1413	1343	481	90	19
DFR 1001 N6A	1945	935	795	1067	610	710	855	875	1070	950	800	710	1250	2045	1645	65	75	140 CL1-2-3	-	1581	1511	528	95	19
DFR 1121 N6A	2160	1065	895	1200	683	800	952	960	1200	1060	900	800	1400	2295	1865	75	80	140 CL1	170 CL2-3	1793	1703	589	105	24
DFR 1251 N6A	2360	1185	1005	1337	770	900	1056	1065	1305	1180	1060	900	1500	2505	2085	80	90	170 CL1-2-3	-	1986	1896	655	105	24
DFR 1401 N6A	2620	1515	1115	1491	854	1000	1175	1165	1455	1320	1120	1000	1700	2815	2515	90	100	170 CL1	210 CL2-3	2243	2133	725	135	24
DFR 1601 N6A	2890	1670	1245	1663	956	1120	1308	1310	1580	1500	1250	1120	1900	3145	2790	100	110	210 CL1-2-3	-	2488	2378	820	135	28
DFR 1801 N6A	3210	1860	1390	1856	1066	1250	1445	1445	1765	1650	1400	1250	2100	3510	3110	110	120	210 CL1-2-3	-	2781	2661	915	160	28
DFR 2001 N6A	3530	2055	1555	2073	1195	1400	1590	1615	1915	1850	1600	1400	2360	3915	3455	120	130	210 CL1-2-3	-	3070	2950	1015	160	28

LG0 - RD0

LG90 - RD 90 Sólo para estas orientaciones. Consultar con oficina técnica para diferentes posiciones / Only for these orientations. Ask our technical office for other positions

LG270 - RD270

RODETE ÁLABES CURVADOS HACIA ATRÁS DE DOBLE ASPIRACIÓN DOUBLE INLET BACKWARD CURVED IMPELLER



DIMENSIONES (mm) (Ejecución 18) / DIMENSIONS (mm) (Arrangement 18)

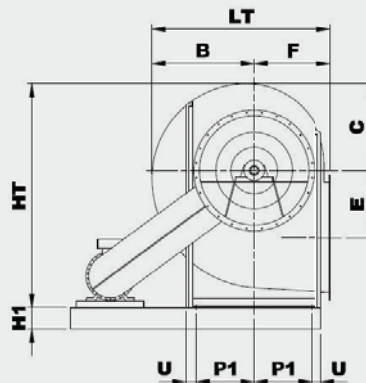
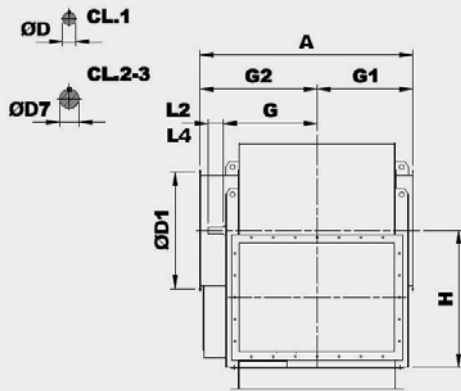

DESCARGA NO ORIENTABLE
DISCHARGE NON ADJUSTABLE

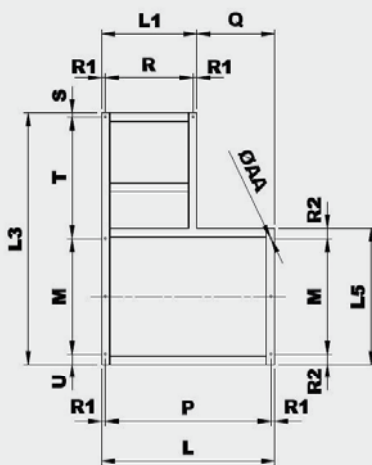

ORIENTACIONES / POSITIONS

LG	0°	45°	90°	135°	180°	225°	270°	315°
RD	0°	45°	90°	135°	180°	225°	270°	315°
	H	H1	H2	H3	H4			

Tipo ventilador Fan type	Ventilador Fan										Eje Shaft				Base ⁽¹⁾ Base ⁽¹⁾										Peso Weight (kg) ⁽²⁾											
	A	B	C	ØD1	E	F	G	G1	G2	H1	H2	H3	H4	HT	LT	ØD	ØD7	L2	L4	L	H1	P	L1	P1		L3	L5	M	Q	R	R1	S	T	U	ØAA	R2
DFR 401 N18A	895	375	330	448	243	285	367	380	515	500	500	285	500	830	660	28	38	60 CL1	80 CL2-3	695	160	635	510	217	1250	574	434	185	450	30	30	716	70	14	70	37
DFR 451 N18A	990	425	370	497	273	320	406	415	575	560	560	320	560	930	745	32	42	80 CL1	110 CL2-3	764	160	704	560	242	1320	624	484	204	500	30	30	736	70	14	70	40
DFR 501 N18A	1080	470	410	551	301	360	455	465	615	630	630	360	630	1040	830	38	48	80 CL1	110 CL2-3	841	160	781	620	267	1400	674	534	221	560	30	30	766	70	14	70	43
DFR 561 N18A	1190	525	455	629	331	400	508	505	685	530	475	400	710	1165	925	38	48	80 CL1	110 CL2-3	927	160	867	690	308	1500	756	616	237	630	30	30	784	70	17	70	48
DFR 631 N18A	1300	590	515	698	375	450	557	565	735	600	530	450	800	1315	1040	42	55	110 CL1-2-3	-	1024	160	964	770	343	1700	826	686	254	710	30	30	914	70	17	70	54
DFR 711 N18A	1490	665	565	775	431	500	626	665	825	670	600	500	850	1415	1165	48	60	110 CL1	140 CL2-3	1153	180	1083	780	386	1900	932	772	373	710	35	35	1013	80	19	80	89
DFR 801 N18A	1615	740	630	861	482	560	693	730	885	750	670	560	1000	1630	1300	55	65	110 CL1	140 CL2-3	1276	180	1206	780	431	2000	1022	862	496	710	35	35	1023	80	19	80	93
DFR 901 N18A	1790	830	705	958	543	630	776	795	995	850	710	630	1120	1825	1460	60	75	140 CL1-2-3	-	1413	180	1343	870	481	2180	1142	962	543	800	35	35	1093	90	19	90	101
DFR 1001 N18A	1945	935	795	1067	610	710	855	875	1070	950	800	710	1250	2045	1645	65	75	140 CL1-2-3	-	1581	200	1511	870	528	2300	1246	1056	711	800	35	35	1114	95	19	95	117
DFR 1121 N18A	2160	1065	895	1200	683	800	952	960	1200	1060	900	800	1400	2295	1865	75	80	140 CL1	170 CL2-3	1793	220	1703	890	589	2450	1388	1178	903	800	45	45	1122	105	24	105	184
DFR 1251 N18A	2360	1185	1005	1337	770	900	1056	1065	1305	1180	1060	900	1500	2505	2085	80	90	170 CL1-2-3	-	1986	220	1896	890	655	2650	1520	1310	1096	800	45	45	1190	105	24	105	195
DFR 1401 N18A	2620	1515	1115	1491	854	1000	1175	1165	1455	1320	1120	1000	1700	2815	2515	90	100	170 CL1	210 CL2-3	2243	220	2133	960	725	2800	1720	1450	1283	850	55	55	1160	135	24	135	235
DFR 1601 N18A	2890	1670	1245	1663	956	1120	1308	1310	1580	1500	1250	1120	1900	3145	2790	100	110	210 CL1-2-3	-	2488	220	2378	960	820	3000	1910	1640	1528	850	55	55	1170	135	28	135	247
DFR 1801 N18A	3210	1860	1390	1856	1066	1250	1445	1445	1765	1650	1400	1250	2100	3510	3110	110	120	210 CL1-2-3	-	2781	250	2661	1020	915	3250	2150	1830	1761	900	60	60	1200	160	28	160	-
DFR 2001 N18A	3530	2055	1555	2073	1195	1400	1590	1615	1915	1850	1600	1400	2360	3915	3455	120	130	210 CL1-2-3	-	3070	250	2950	1020	1015	3550	2350	2030	2050	900	60	60	1300	160	28	160	-

¹ Para los ventiladores con orientaciones 180° y 225°, contactar con oficina técnica / For fans with 180° and 225° positions, please contact our technical office

² Peso de la base / Base weight

LG0 - RD0

LG90 - RD 90

LG270 - RD270

Sólo para estas orientaciones. Consultar con oficina técnica para diferentes posiciones / Only for these orientations. Ask our technical office for other positions

RODETE ÁLABES CURVADOS HACIA ATRÁS DE DOBLE ASPIRACIÓN DOUBLE INLET BACKWARD CURVED IMPELLER

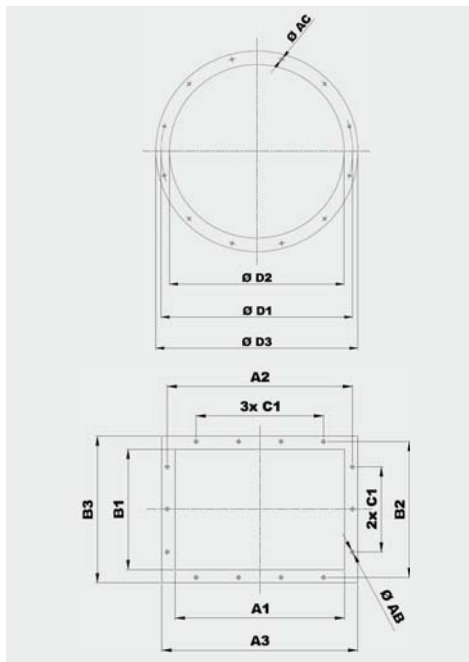

Modelo Model	Brida aspiración Inlet flange					
	Tipo brida Bride type	Ø D1	Ø D2	Ø D3	Ø AC	Agujeros Holes
401	400	448	405	485	10	12
451	450	497	455	535	10	12
501	500	551	505	585	10	12
561	560	629	566	666	10	12
631	630	698	636	736	10	12
711	710	775	716	816	12	16
801	800	861	806	906	12	16
901	900	958	906	1006	12	16
1001	1000	1067	1007	1107	12	24
1121	1120	1200	1128	1248	12	24
1251	1250	1337	1260	1380	12	24
1401	1400	1491	1420	1540	12	32
1601	1600	1663	1610	1730	14	32
1801	1800	1856	1810	1930	14	32
2001	2000	2073	2010	2130	14	32

Modelo Model	Brida descarga Discharge flange										
	Tipo brida Bride type	A1	B1	A2	B2	A3	B3	C1	Ø AB	NºX	NºY
401	560x400	569	404	629	464	669	504	160	14	4+4	3+3
451	630x450	638	453	698	513	738	553	160	14	4+4	3+3
501	710x500	715	507	775	567	815	607	160	14	5+5	3+3
561	800x560	801	569	871	639	921	689	200	14	4+4	3+3
631	900x630	898	638	968	708	1018	758	200	14	5+5	4+4
711	1000x710	1007	715	1077	785	1127	835	200	14	5+5	4+4
801	1120x800	1130	801	1210	881	1270	941	200	18	6+6	4+4
901	1250x900	1267	898	1347	978	1407	1038	200	18	7+7	5+5
1001	1400x1000	1421	1007	1501	1087	1561	1147	200	18	7+7	5+5
1121	1600x1120	1593	1130	1683	1220	1753	1290	200	22	8+8	6+6
1251	1800x1250	1786	1267	1876	1357	1946	1427	200	22	9+9	7+7
1401	2000x1400	2003	1421	2093	1511	2163	1581	200	22	10+10	7+7
1601	2240x1600	2248	1593	2348	1693	2428	1773	200	22	12+12	8+8
1801	2500x1800	2521	1786	2621	1886	2701	1966	200	22	13+13	9+9
2001	2800x2000	2810	2003	2910	2103	2990	2183	200	22	14+14	10+10

AMORTIGUADORES / SILENT BLOCKS

Amortiguadores recomendados / Suggested silent blocks

Ventilador / Fan	Ejecución 6 / Arrangement 6	Ejecución 18 / Arrangement 18 Clase 1 / Class 1	Ejecución 19 / Arrangement 19 Clase 2-3 / Class 2-3
401	4 x AM 30 - 30 x 30	6 x AM 30 - 30 x 30	6 x AM 40 - 40 x 30
451	4 x AM 40 - 40 x 30	6 x AM 40 - 40 x 30	6 x AM 50 - 50 x 40
501	4 x AM 40 - 40 x 30	6 x AM 40 - 40 x 30	6 x AM 50 - 50 x 40
561	4 x AM 50 - 50 x 40	6 x AM 50 - 50 x 40	6 x AM 75 - 75 x 50
631	4 x AM 50 - 50 x 40	6 x AM 50 - 50 x 40	6 x AM 75 - 75 x 50
711	4 x AM 75 - 75 x 50	6 x AM 75 - 75 x 50	6 x AZ 39 - 140 x 39
801	4 x AM 75 - 75 x 50	6 x AM 75 - 75 x 50	6 x AZ 39 - 140 x 39
901	4 x AZ 39 - 140 x 39	6 x AZ 39 - 140 x 39	6 x AZ 39 - 140 x 39
1001	4 x AZ 39 - 140 x 39	6 x AZ 39 - 140 x 39	6 x AZ 51 - 132 x 51
1121	4 x AZ 51 - 132 x 51	6 x AZ 51 - 132 x 51	6 x AZ 51 - 132 x 51
1251	4 x AZ 51 - 132 x 51	6 x AZ 51 - 132 x 51	6 x AZ 51 - 132 x 51
1401	4 x AZ 51 - 132 x 51	6 x AZ 51 - 132 x 51	6 x AZ 63 - 150 x 63
1601	-	6 x AZ 51 - 132 x 51	6 x AZ 63 - 150 x 63
1801	-	6 x AZ 63 - 150 x 63	6 x AZ 63 - 150 x 63
2001	-	6 x AZ 63 - 150 x 63	6 x AZ 63 - 150 x 63

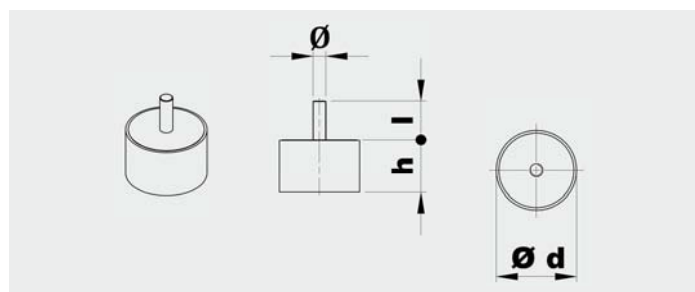

Tipo Type	Carga para 4 soportes / Load for 4 supports (kg)	d	h	Ø	l	Peso / Weight (kg)
AM30	81÷140	30	30	M8	20	0,05
AM40	141÷224	40	30	M8	23	0,10
AM50	225÷315	50	40	M10	28	0,20
AM75	316÷630	75	50	M12	37	0,50

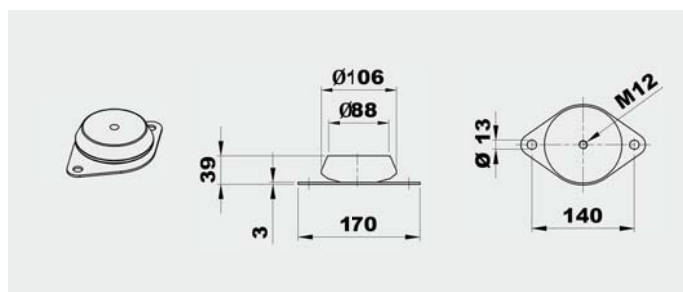

Tipo Type	Carga para 4 soportes / Load for 4 supports (kg)	Peso / Weight (kg)
AZ 39	631÷1250	0,7

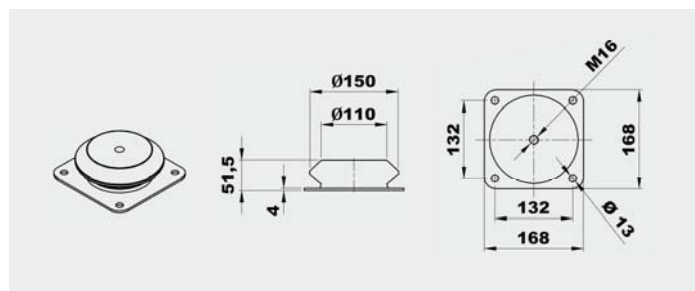

Tipo Type	Carga para 4 soportes / Load for 4 supports (kg)	Peso / Weight (kg)
AZ 51	1121÷1401	1,8

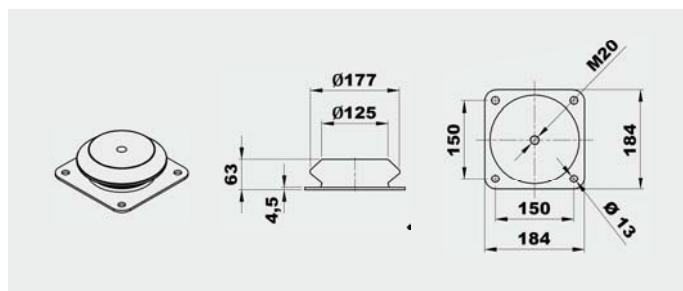

Tipo Type	Carga para 4 soportes / Load for 4 supports (kg)	Peso / Weight (kg)
AZ 63	1601÷2001	2,5

ACCESORIOS / ACCESSORIES

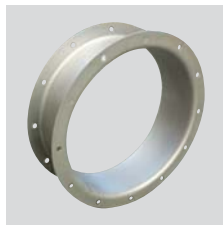

CA (CFH1) - CFH2 - CFH3
 Contrabrida -
 Brida plana circular.
*Counter-flange -
 Circular flange.*

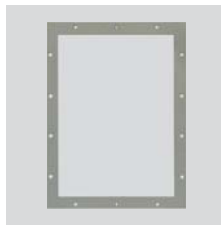

CP
 Brida plana
 rectangular.
Rectangular Flange.

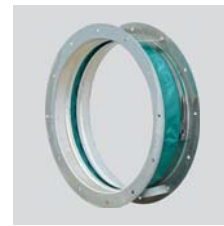

GA
 Junta flexible
 aspiración.
*Inlet flexible
 connector.*



GP
 Junta flexible
 descarga.
*Outlet flexible
 connector.*



DP
 Regulador de caudal
 de aspiración.
*Inlet damper
 governor.*



SAD
 Compuerta de
 regulación de caudal
 de descarga.
*Air reducing damper
 at outlet.*



SF
 Válvula mariposa.
Throttle valve.



DF
 Filtro en la
 aspiración.
Air filter at inlet.

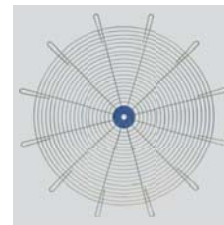

RC
 Rejilla de protección
 para la aspiración.
Protection net.



AM/AZ
 Soportes
 antivibratorios.
Silent blocks.



SCSO
 Silenciador
 cilíndrico.
*Cylindrical sound
 attenuator.*



SCCO
 Silenciador cilíndrico
 con bulbo.
*Cylindrical sound
 attenuator with
 internal pot.*

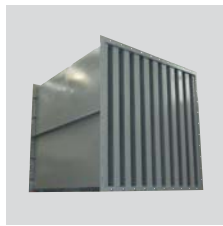

SASS
 Silenciador
 rectangular.
*Baffle type sound
 attenuator.*



CI
 Cabina de
 insonorización.
Noise enclosure.

Ver información completa en "Accesorios de montaje".
 For more information see "Mounting accessories".